



# Medtronic

PHYSIO-CONTROL

## LIFEPAK<sup>®</sup> CR-T

AED Trainer

Simulateur DSA

AED Trainer

Entrenador del DEA

Trainer DAE

AED Trainer

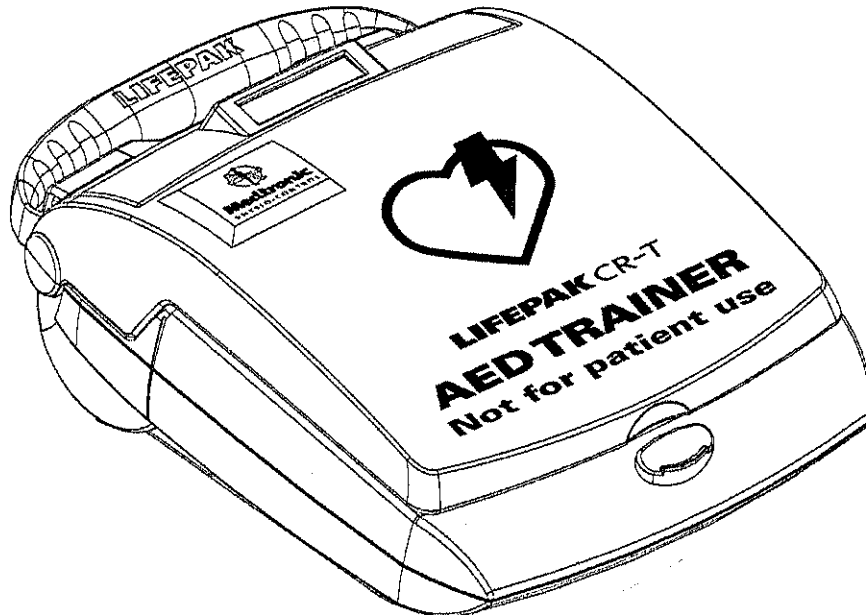

---

Operating Instructions ■ Instructions de fonctionnement ■  
Gebrauchsanweisung ■ Instrucciones de uso ■ Istruzioni operative ■  
Gebruiksaanwijzing





**OPERATING INSTRUCTIONS**

**LIFEPAK® CR-T**  
AED Trainer

---

## IMPORTANT

This instrument is to be used by authorized personnel only.

### Text Conventions

Throughout these operating instructions, special text characters are used to indicate labels and voice prompts:

- Operating control labels: CAPITAL LETTERS such as LID RELEASE/ON-OFF.
- Voice prompts: CAPITAL ITALICIZED LETTERS such as CALL FOR HELP NOW.

### Version History

These operating instructions describe the LIFEPAK CR-T AED Trainer, part number 3201804-000 to -004 or later.



**Medtronic Physio-Control**  
11811 Willows Road Northeast  
Post Office Box 97006  
Redmond, WA 98073-9706 USA  
Telephone: 425.867.4000  
Toll Free (USA only): 800.442.1142  
Fax: 425.867.4121  
Internet: [www.physiocontrol.com](http://www.physiocontrol.com)  
[www.medtronic.com](http://www.medtronic.com)

**Medtronic Europe S.A.**  
Medtronic Physio-Control  
Rte. du Molliau 31  
Case postale 84  
1131 Tolochenaz  
Switzerland  
Telephone: 41.21.802.7000  
Fax: 41.21.802.7900

---

PHYSIO-CONTROL and LIFEPAK are registered trademarks of Medtronic Physio-Control Corp. CHARGE-PAK and QUIK-PAK are trademarks of Medtronic Physio-Control Corp. Medtronic is a registered trademark of Medtronic, Inc. Specifications are subject to change without notice.  
©May 2002 Medtronic Physio-Control Corp. All rights reserved.

PN 3201838-961

## TABLE OF CONTENTS

### 1 Getting Started

Introduction .....	2
Unpacking and Inspecting the LIFEPAK CR-T AED Trainer .....	2
Controls, Indicators, and Labels .....	3
Outside Controls, Indicators, and Labels .....	3
Remote Control and Remote Control Cable .....	7
Installing and Replacing Batteries .....	8
Installing and Replacing Trainer Batteries .....	8
Installing and Replacing Remote Control Batteries.....	8

### 2 Using the LIFEPAK CR-T AED Trainer

Voice Prompts and Tones .....	10
Using the Remote Control .....	10
Remote Control Functions .....	10
Using the Remote Control Cable .....	12
Preparing for a Training Session .....	13
Conducting a Training Session .....	14
Following a Training Session .....	14

### 3 Setup

Setup Configuration and Operating Settings .....	16
Changing Options for Operating Settings .....	18
Using the Remote Control and the LED Display .....	18
Procedures for Changing Operating Settings.....	18
Shock Protocol .....	18
Selecting Shock Protocols.....	18
Configuring Custom Shock Protocols.....	19
General Operating Settings.....	20
CPR Time.....	21
Language Option.....	21

---

<b>4 Caring for the LIFEPAK CR-T AED Trainer</b>	
Replacing Batteries .....	24
Troubleshooting .....	24
Cleaning .....	26
Product Recycling Information .....	26
Recycling Assistance .....	26
Preparation.....	26
Recycling of Training Electrodes .....	26
Packaging.....	26
Warranty .....	26
Accessories .....	27
Specifications .....	27

---

<b>Appendixes</b>	
<b>A LIFEPAK CR-T AED TrainerVoice Prompts and Tones .....</b>	<b>29</b>
<b>B LIFEPAK CR-T AED TrainerQuick Start Reference Card .....</b>	<b>33</b>
<b>C Declaration of Conformity .....</b>	<b>37</b>

---

<b>Index.....</b>	<b>41</b>
-------------------	-----------

## LIST OF FIGURES

Figure 1	LIFEPAK CR–T AED Trainer Outside Controls, Indicators, and Labels (Top and Bottom).....	3
Figure 2	LIFEPAK CR–T AED Trainer Outside Controls, Indicators, and Labels (Back and Side).....	4
Figure 3	LIFEPAK CR–T AED Trainer Inside Features.....	5
Figure 4	Inside Features after Opening the Electrode Packet.....	6
Figure 5	Remote Control and Remote Control Cable.....	7
Figure 6	LIFEPAK CR–T AED Trainer and Remote Control Battery Placement.....	8
Figure 7	Connecting the Training Electrode Packet to the LIFEPAK CR–T AED Trainer.....	13
Figure 8	Placing Training Electrodes on the Manikin.....	14
Figure 9	LED Display.....	18
Figure 10	Custom #1 and #2 Options.....	19
Figure 11	General Operating Setting Options.....	20
Figure 12	CPR Time Options.....	21
Figure 13	Language Options.....	21

## LIST OF TABLES

Table 1	Outside Controls, Indicators, and Labels (Top and Bottom).....	3
Table 2	Outside Controls, Indicators, and Labels (Back and Side).....	4
Table 3	Inside Features.....	5
Table 4	Inside Features after Opening the Electrode Packet.....	6
Table 5	Remote Control Features.....	7
Table 6	Remote Control Button Functions.....	10
Table 7	Trainer Operating Setting Options.....	16
Table 8	Shock Protocol Options.....	19
Table 9	General Operating Setting Options.....	20
Table 10	Language Groups.....	21
Table 11	Voice Prompts and Tones Troubleshooting.....	24
Table 12	LED Display Troubleshooting.....	24
Table 13	Setup Options Troubleshooting.....	25
Table 14	Remote Control Troubleshooting.....	25
Table 15	Training Electrodes Troubleshooting.....	25
Table 16	LIFEPAK CR–T AED Trainer Accessories.....	27
Table 17	LIFEPAK CR–T AED Trainer Specifications.....	27
Table 18	Remote Control Specifications.....	28



## 1 GETTING STARTED

This section introduces the LIFEPAK® CR-T Automated External Defibrillator (AED) Trainer and provides an orientation to its features.

Introduction	page 2
Unpacking and Inspecting the LIFEPAK CR-T AED Trainer	2
Controls, Indicators, and Labels	3
Installing and Replacing Batteries	8

---

## INTRODUCTION

The LIFEPAK CR-T AED Trainer provides the necessary interface for practical skill demonstration during a simulated cardiac arrest. The Trainer is designed to assist the instructor with realistic training on the use of the defibrillator without the actual charge and discharge of electrical energy.

The Trainer simulates voice prompts, audible tones, and readiness display features of all LIFEPAK CR defibrillator models. These features help guide trainees through simulated analysis, simulated shock delivery, and prompted CPR time.

An infrared, wireless, remote control allows the instructor to operate the Trainer during training sessions. Labeled buttons on the remote control are used to define operating settings for training scenarios and, while training is in progress, pause Trainer operation or interrupt preset training scenarios. Optional operating settings offer flexibility and a variety of potential setup configurations.

The Trainer and remote control are intended for indoor use under normal room temperature and lighting conditions.

**Note:** The Trainer does not provide training for the defibrillator data management functions.

---

## UNPACKING AND INSPECTING THE LIFEPAK CR-T AED TRAINER

After receiving the LIFEPAK CR-T AED Trainer, carefully remove the Trainer and the operating instructions from the shipping container. Examine the Trainer and accessories for any sign of damage during shipping.

Shipping container contents include:

- LIFEPAK CR-T AED Trainer
- QUIK-PAK™ training electrodes
- Yellow plastic shock key cover
- Remote control
- Remote control cable
- CHARGE-PAK™ Trainer
- Operating instructions
- Quick reference card
- Soft case with identification card
- Lid labels (international trainers only)
- 4 D-cell alkaline batteries (for Trainer)
- 2 AAA alkaline batteries (for remote control)

If any components are missing or the Trainer appears to be damaged, contact your dealer or local Medtronic Physio-Control representative right away. Save the container for reshipping the Trainer if necessary.

**Note:** Always place the Trainer in a location separate from the defibrillator to avoid confusion in real emergencies.

## CONTROLS, INDICATORS, AND LABELS

There are several important controls, indicators, and labels on the LIFEPAK CR-T AED Trainer with which you should become familiar.

### Outside Controls, Indicators, and Labels

The outside controls, indicators, and labels are identified in Figure 1 and Figure 2 and described in Table 1 and Table 2.

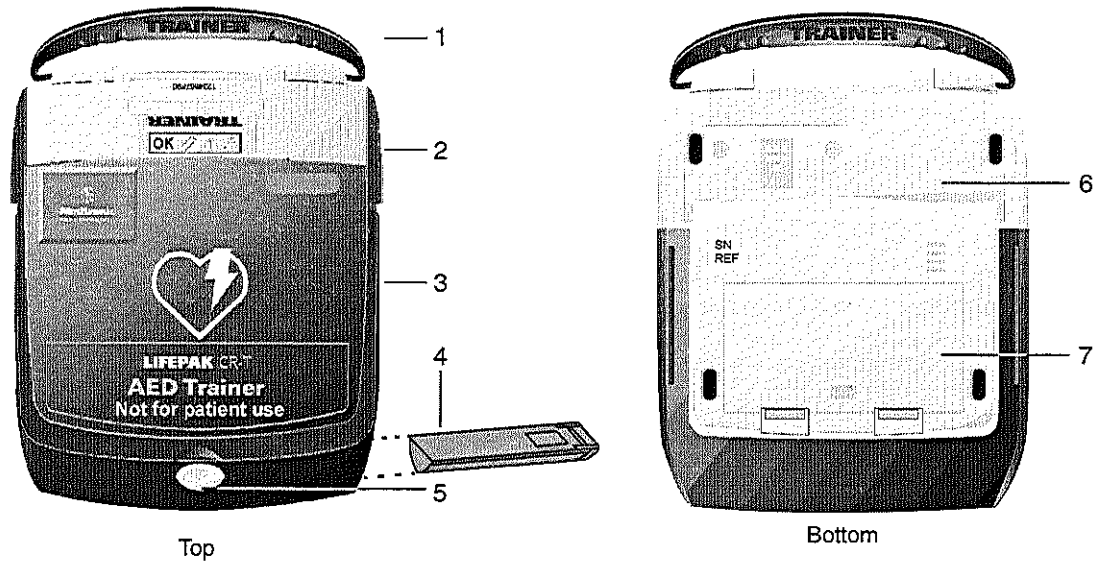





Figure 1 LIFEPAK CR-T AED Trainer Outside Controls, Indicators, and Labels (Top and Bottom)

Table 1 Outside Controls, Indicators, and Labels (Top and Bottom)

1	Carrying handle	The carrying handle is used to transport the Trainer.
2	Readiness display	This display simulates whether the defibrillator is ready for use or needs attention. The remote control and CHARGE-PAK activate the following indicators: <ul style="list-style-type: none"> <li><b>OK</b> OK indicator. Simulates that the defibrillator is ready for use.</li> <li> CHARGE-PAK indicator. Simulates that the CHARGE-PAK needs to be replaced or is not installed.</li> <li> Attention indicator. Simulates that the internal battery of the defibrillator is low.</li> <li> Wrench indicator. Simulates that there is a condition that prevents or could prevent normal operation of the defibrillator. Service is required.</li> </ul>
3	Lid	The top of the Trainer. After the lid is open, the Trainer begins training scenarios. When the lid is closed, the Trainer simulates the defibrillator in OFF status.
4	CHARGE-PAK Trainer	The CHARGE-PAK Trainer is not functional. It is used only to demonstrate how to remove and replace the CHARGE-PAK.
5	Lid release/On-Off button	Button that opens the Trainer lid and simulates turning on the defibrillator. Pressing this button for approximately 2 seconds after the lid is open simulates turning off the defibrillator.

**Table 1** Outside Controls, Indicators, and Labels (Top and Bottom) (Continued)

<b>6</b>	Storage compartment	Storage compartment for the remote control cable and shock button cover.
<b>7</b>	Battery compartment	Compartment that holds four D-cell alkaline batteries.

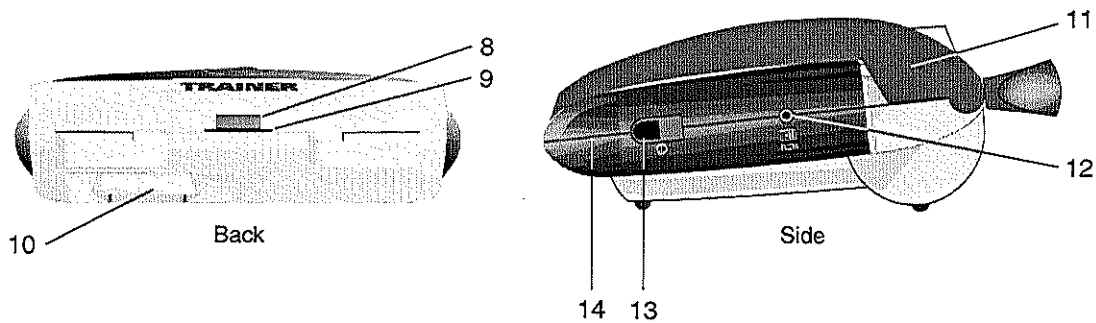

**Figure 2** LIFEPAK CR-T AED Trainer Outside Controls, Indicators, and Labels (Back and Side)

**Table 2** Outside Controls, Indicators, and Labels (Back and Side)

<b>8</b>	Remote control signal sensor	Sensor used for wireless remote control operation. The signal from the remote control must be detected at this sensor for proper communication.
<b>9</b>	Light emitting diode (LED) display	Display containing ten LED bars that are viewed to confirm selections when operating settings are changed. The LED display is also used to verify volume level when the volume is adjusted.
<b>10</b>	Remote control compartment	Storage compartment for the remote control.
<b>11</b>	Software download receptacle	Connection point for loading software to the Trainer. To be used only by authorized Medtronic Physio-Control personnel.
<b>12</b>	Remote control receptacle	Connection point for the remote control cable.
<b>13</b>	Master power switch	Press and release switch that provides power to the Trainer.
<b>14</b>	CHARGE-PAK Trainer compartment	Compartment that accommodates the removable CHARGE-PAK Trainer.

## Inside Features

When the Trainer lid is opened, you will see the electrode packet and the release handle shown in Figure 3. Figure 4 shows the features you see after releasing the electrode packet. Table 3 and Table 4 describe the inside features shown in Figure 3 and Figure 4.

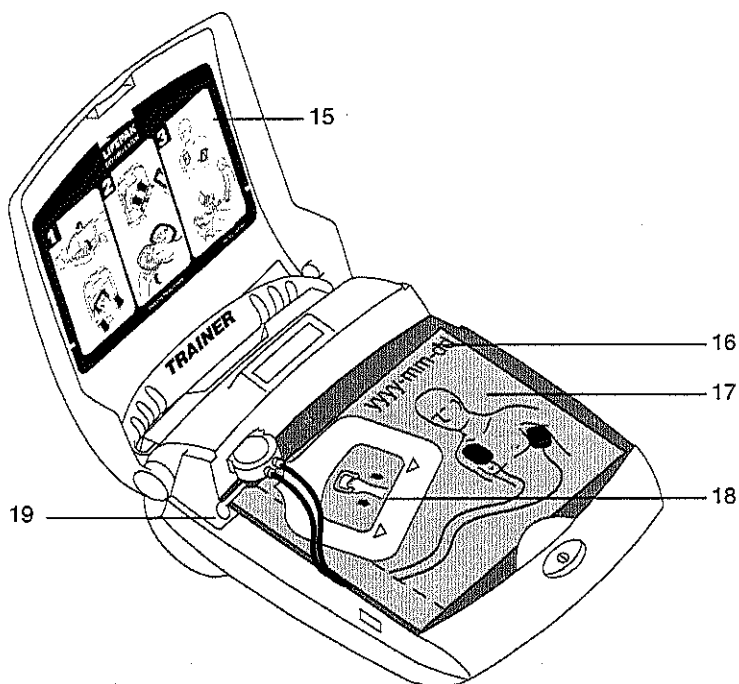
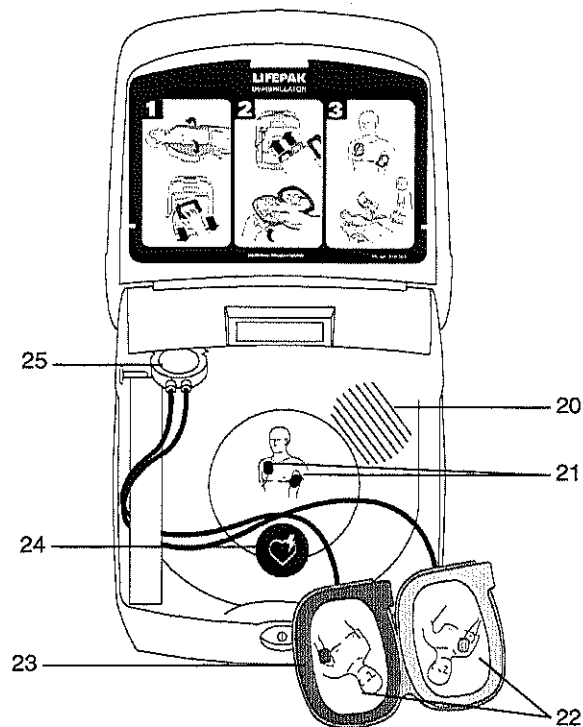

Figure 3 LIFEPAK CR-T AED Trainer Inside Features

Table 3 Inside Features

15 Quick reference card	An illustrated and condensed guide for using the Trainer.
16 Use By date	Use By date shown: yyyy-mm-dd. This simulated date is visible when the plastic lid is open or closed.
17 QUIK-PAK electrode packet	Packet that holds a set of training electrode pads.
18 Electrode packet release handle	Pulling this red handle tears open the training electrode packet and releases the training electrode pads.
19 Electrode packet anchor pin	Pin that secures the training electrode packet to the Trainer.



**Figure 4** Inside Features after Opening the Electrode Packet

**Table 4** Inside Features after Opening the Electrode Packet

<b>20</b> Speaker	Speaker that projects the voice prompts and tones.
<b>21</b> Electrode pad indicators	Indicators that automatically flash red when the Trainer lid is opened, alerting the trainee that the electrode pads are NOT applied to the training manikin.  Indicators turn solid green when the instructor presses the <b>ELECTRODE PADS</b> button to indicate the electrode pads were properly applied during the training scenario.  Refer to page 11 for information about using the <b>ELECTRODE PADS</b> button.
<b>22</b> Training electrode pads	Training electrode pads to be applied to the training manikin.
<b>23</b> Blue plastic	Blue plastic liner that protects the adhesive until the electrode pads are used.
<b>24</b> Training shock button	Pressing this red flashing button simulates the delivery of a shock by the defibrillator semiautomatic model. (The trainee cannot deliver a simulated shock unless a Trainer voice prompt instructs them to do so.)  When training simulates the defibrillator automatic model, cover this button with the yellow shock button cover.
<b>25</b> Electrode connector	Connects the electrode pads to the Trainer. The connection is not functional—simulated connection/disconnection is initiated by means of the remote control.

## Remote Control and Remote Control Cable

The remote control, stored in the remote control compartment (refer to page 4), is used to configure the Trainer operating settings prior to a training session and to alter simulation during training scenarios. The remote control communicates with the Trainer through signals to the infrared sensor located in the back of the Trainer.

The remote control cable, stored in the storage compartment (refer to pages 3 and 4), can be used as an alternative to the infrared sensor. Refer to Section 2, beginning on page 9, for information about connecting the remote control cable.

Figure 5 shows the remote control and remote control cable with the features identified in Table 5. Remote control button functions are described in Section 2, beginning on page 10.

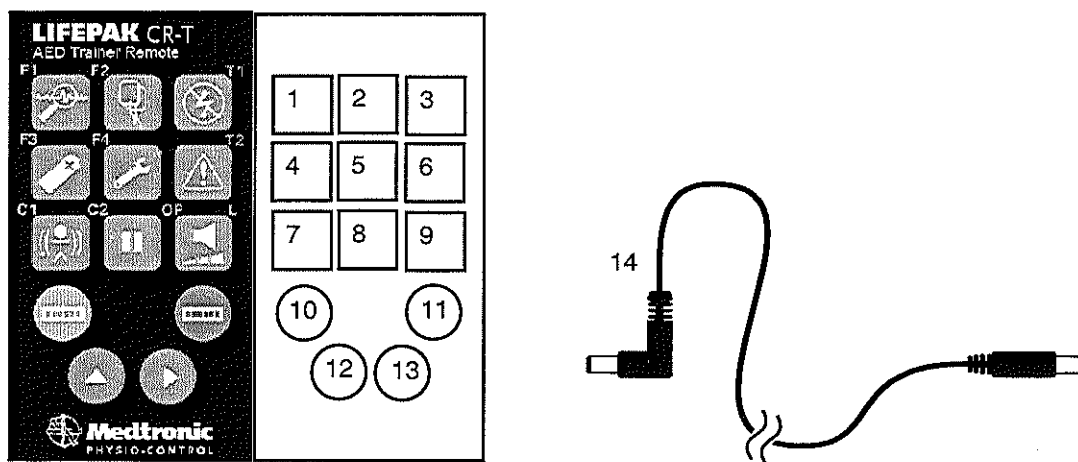

Figure 5 Remote Control and Remote Control Cable

Table 5 Remote Control Features

- |   |                                  |
|---|----------------------------------|
| 1 Continuous patient surveillance system (CPSS) button (F1) | 8 Pause button (C2)              |
| 2 Electrode pads button (F2)                                | 9 Volume control button (OP) (L) |
| 3 No advised shock button (T1)                              | 10 Green select button           |
| 4 CHARGE-PAK button (F3)                                    | 11 Red select button             |
| 5 Service button (F4)                                       | 12 Up arrow button               |
| 6 Attention button (T2)                                     | 13 Right arrow button            |
| 7 Motion button (C1)  | 14 Remote control cable          |

## INSTALLING AND REPLACING BATTERIES

The following paragraphs provide the procedures for installing or replacing LIFEPAK CR-T AED Trainer and remote control batteries.

### Installing and Replacing Trainer Batteries

Four D-cell alkaline batteries provide power to the Trainer. The batteries are installed in a compartment in the bottom of the Trainer. Fresh batteries provide approximately 100 hours of continuous Trainer operation.

To install the batteries:

- 1 Verify that power to the Trainer has been turned off (using the MASTER POWER switch).
- 2 Carefully turn the Trainer upside down.
- 3 Remove the battery compartment cover by depressing both latches on the cover and lifting the cover.
- 4 Insert four fresh, identical batteries, taking care to align the (+) and (-) terminals correctly. The correct battery placement is shown in Figure 6.
- 5 Replace the cover and press down until you hear the latches snap into place.

**Note:** Always replace all of the batteries at the same time. Always use four identical batteries.

**Note:** For permanent storage (longer than six months), remove the batteries from the battery compartment. If the Trainer is used infrequently (approximately once every six months), the batteries can remain in the battery compartment.

### Installing and Replacing Remote Control Batteries

Two AAA alkaline batteries provide power to the remote control. The batteries are located in a compartment on the bottom of the remote control. (See Figure 6.)

To replace the remote control batteries:

- 1 Turn the remote control upside down.
- 2 Open the battery compartment by sliding the battery compartment cover down with firm thumb pressure.
- 3 Insert two fresh, identical batteries, taking care to align the (+) and (-) terminals correctly.
- 4 Replace the battery compartment cover, sliding it up until it snaps securely into place.

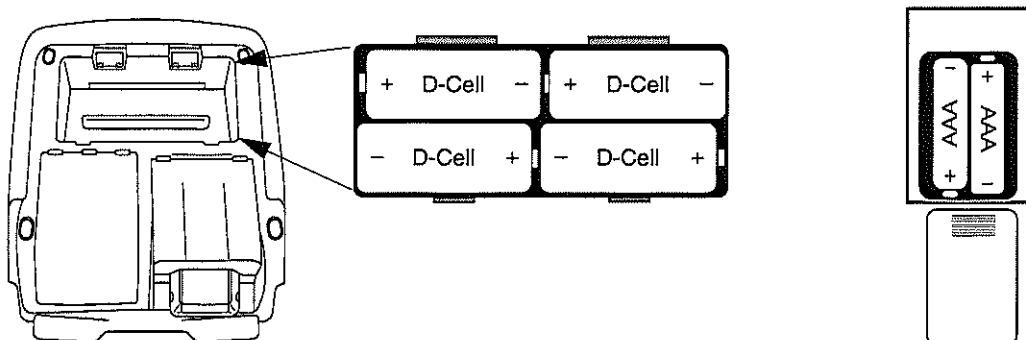

Figure 6 LIFEPAK CR-T AED Trainer and Remote Control Battery Placement

## 2 USING THE LIFEPAK CR-T AED TRAINER

This section provides information and instructions for using the LIFEPAK CR-T AED Trainer.

Voice Prompts and Tones	page 10
Using the Remote Control	10
Preparing for a Training Session	13
Conducting a Training Session	14
Following a Training Session	14

---

## VOICE PROMPTS AND TONES

The LIFEPAK CR-T AED Trainer voice prompts provide the trainee with step-by-step instructions for responding to training scenarios. For a complete list of voice prompts, refer to Appendix A, page 31.

---

## USING THE REMOTE CONTROL

The remote control allows the instructor to:

- Preset operating settings in a setup configuration (refer to Section 3, beginning on page 15).
- Pause LIFEPAK CR-T AED Trainer operation.
- Interrupt preset routines with *NO SHOCK ADVISED*, *CHECK PADS FOR GOOD CONTACT*, *MOTION*, *LOW BATTERY*, and Continuous Patient Surveillance System prompts.
- Select any one of the six available shock protocols.

The remote control communicates with the Trainer by using wireless infrared signals or the remote control cable. The signal indicator acknowledges remote control signals received, both with and without the remote control cable.

- One red flash indicates that a signal was received from the remote control and that the Trainer is responding accordingly.
- Three red flashes indicate that an invalid remote control key was pressed and that Trainer operation is unchanged.
- A continuous red light indicates that the Trainer is in pause mode.

To use the remote control without the cable, the instructor must stand behind the Trainer. During use, the instructor must hold the remote control level rather than aiming it directly at the Trainer.

### Remote Control Functions

Remote control button functions are described in Table 6. The Trainer is designed for maximum flexibility. Your defibrillator may not have all of the functions identified in Table 6.

Refer to Section 3 for a description of the alternate remote control functions, for example, F1.

Table 6 Remote Control Button Functions













Button	Function	Operation and Description
F1 	Simulates CPSS	The CPSS button is used only when monitoring is set to ON.  The Trainer enters the monitoring state after three <i>NO SHOCK ADVISED</i> prompts. Press the CPSS button to simulate detection of a possible shockable rhythm after the Trainer enters the monitoring state.

Table 6 Remote Control Button Functions (Continued)

Button	Function	Operation and Description
F2 	Simulates electrode pads application	<p>The ELECTRODE PADS button is used to indicate whether or not the electrode pads are properly applied to the manikin.</p> <p>After the trainee applies the electrode pads to the manikin, press the ELECTRODE PADS button to change the ELECTRODE PAD indicators to solid green. Press the ELECTRODE PADS button a second time to initiate the <i>CHECK PADS FOR GOOD CONTACT</i> voice prompt and to change the ELECTRODE PAD indicators to flashing red, indicating that the training electrodes were not applied properly or were disconnected after they were properly applied. Press the ELECTRODE PADS button a third time after the training electrodes are properly applied to continue the training scenario.</p>
T1 	Change shock to no shock advised	<p>The NO SHOCK ADVISED button can be used only during simulated analysis.</p> <p>Press the NO SHOCK ADVISED button to change any shock within a shock protocol to <i>NO SHOCK ADVISED</i>.</p>
F3 	Simulates the CHARGE-PAK needs to be replaced	<p>The CHARGE-PAK button can be used only when the Trainer is in simulated OFF status (MASTER POWER switch ON, LID RELEASE/ON-OFF button OFF).</p> <p>Press the CHARGE-PAK button once to activate the CHARGE-PAK indicator in the readiness display.</p> <p>The CHARGE-PAK indicator automatically appears on the readiness display after simulating a patient use.</p> <p>To clear the CHARGE-PAK indicator from the readiness display, remove and replace the CHARGE-PAK. The instructor can also clear the indicator by pressing the button a second time.</p>
F4 	Simulates a call for service situation	<p>The WRENCH button can be used only when the Trainer is in simulated OFF status.</p> <p>Press the WRENCH button once to activate the wrench indicator in the readiness display.</p> <p>To clear the WRENCH indicator from the readiness display, press the button a second time.</p>
T2 	Attention	<p>The ATTENTION button can be used when the Trainer is ON and when it is in simulated OFF status.</p> <p>Press the ATTENTION button once to activate the ATTENTION indicator in the readiness display. This simulates a low internal battery condition (simulating a situation in which the actual defibrillator would have a minimum of 6 shocks or 42 minutes of monitoring time available for use).</p> <p>To clear the ATTENTION indicator from the readiness display, press the ATTENTION button a second time.</p>
C1 	Start or stop simulated motion	<p>The MOTION button is used only during simulated analysis.</p> <p>Press the MOTION button to start simulated motion. The Trainer interrupts simulated analysis and delivers <i>MOTION DETECTED</i> prompts until the instructor presses the MOTION button again.</p>

**Table 6 Remote Control Button Functions (Continued)**

Button	Function	Operation and Description
	Pause	<p>The PAUSE button suspends the Trainer in its present state and causes the LED display to illuminate red until operation is resumed. This allows the instructor to interject other instruction, if necessary. The Trainer will pause for approximately 30 minutes before it turns completely off.</p> <p>Pressing the PAUSE button a second time resumes Trainer operation.</p>
	Adjust volume of voice prompts	<p>Each time the Trainer is turned on, the volume level defaults to the level used during the previous session.</p> <p>Three volume levels are available (low, medium, high). Press the VOLUME CONTROL button to select the volume level desired. As you press the button, the volume increases. View the LED display to observe volume changes. When the highest volume is reached, the next press returns the volume to low.</p>
	GREEN SELECT button	<p>The GREEN SELECT button is used to change the shock protocol and general operating setting options.</p> <p>When the GREEN SELECT button is pressed, the LED display flashes green to indicate setup mode is activated.</p> <p>Press the GREEN SELECT button twice to display the shock protocol.</p> <p>For more information, refer to Section 3, beginning on page 15.</p>
	RED SELECT button	<p>The RED SELECT button is used to change CPR Time 1, CPR Time 2, and the Language Option.</p> <p>When the RED SELECT button is pressed, the LED display flashes red to indicate setup mode is activated.</p> <p>For more information, refer to Section 3, beginning on page 15.</p>
	UP ARROW button	<p>The UP ARROW button is used to select a setting option.</p>
	RIGHT ARROW button	<p>The RIGHT ARROW button is used to advance through the settings.</p>

**Using the Remote Control Cable**

To use the remote control cable, insert the cable's right-angle connector into the remote control receptacle. Insert the connector on the opposite end of the cable into the receptacle located on the side of the Trainer (see Figure 2, page 4).

Disconnect the remote control cable by grasping the connector on the side of the Trainer and gently pulling away from the Trainer. Disconnect the right-angle connector from the remote control in the same way.

## PREPARING FOR A TRAINING SESSION

- 1 Connect the electrode packet to the Trainer as follows:
  - Press the LID RELEASE/ON-OFF button to open the Trainer lid.
  - Insert the electrode pads connector into the Trainer cable receptacle until it snaps into place (see Figure 7).
  - Insert the black plastic anchor pin on the electrode packet into the anchor receptacle at the upper left corner of the Trainer (see Figure 7).
  - Ensure that the lower edge of the packet is under the fin on the lower front part of the Trainer.
  - After the electrode packet is in place, close the Trainer lid.
- 2 Slide and release the MASTER POWER switch to provide power to the Trainer.
- 3 Check to confirm that the existing setup configuration is appropriate for the training scenario. If not, change the setup configuration as desired (refer to Section 3, beginning on page 15, for setup information).
- 4 If preparing for a training session on the automatic model of the defibrillator, place the yellow plastic cover, stored in the storage compartment (refer to pages 3 and 4), over the SHOCK button.

Two Quick Start Reference Cards are provided in Appendix B, beginning on page 33. These cards include a condensed description of the steps to complete when preparing the Trainer for a training scenario. The cards are perforated for easy removal and may be photocopied.

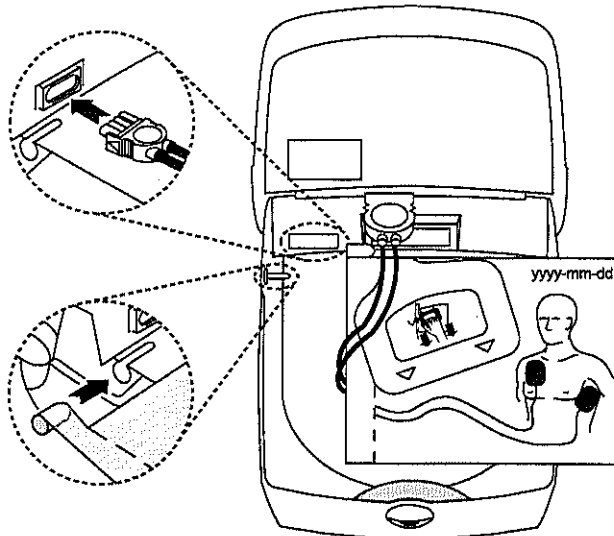

Figure 7 Connecting the Training Electrode Packet to the LIFEPAK CR-T AED Trainer

---

## CONDUCTING A TRAINING SESSION

- 1 Verify that power to the Trainer is on and the OK indicator appears in the readiness display.
- 2 Proceed with the training session.

**Note:** Ensure that the trainee does not touch the adhesive on the QUIK-PAK training electrodes or allow a training electrode to fold over on itself. Also ensure that the training electrodes are correctly oriented on the manikin as shown on the electrode packet (see Figure 8).

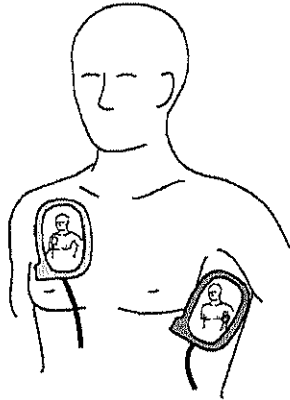

Figure 8 Placing Training Electrodes on the Manikin

**Note:** If the QUIK-PAK training electrodes accidentally detach from the manikin or disconnect from the Trainer, the *CHECK PADS FOR GOOD CONTACT* voice prompt will **not** sound. The instructor must press the **ELECTRODE PADS** button on the remote control to indicate that the electrode pads are disconnected.

- 3 Upon ending a training scenario, press the lid release/ON-OFF button or close the Trainer lid to simulate turning off the defibrillator. The *CHARGE-PAK* indicator automatically appears on the readiness display. To clear this indicator, the trainee must remove and reinsert the *CHARGE-PAK* or the instructor must press the *CHARGE-PAK* button (F3).

---

## FOLLOWING A TRAINING SESSION

- 1 Remove the training electrodes from the manikin by grasping the electrode pad at the cable end and peeling it away from the manikin at a 45° angle. Do not remove the training electrodes from the manikin by pulling on the cable.
- 2 Reassemble the QUIK-PAK training electrode packet for the next training session.
- 3 Slide and release the *MASTER POWER* switch to turn off the Trainer. (The Trainer automatically turns off after 15 minutes of inactivity.)
- 4 Care for the Trainer as appropriate (refer to Section 4, beginning on page 23).

**Note:** Always place the Trainer in a location separate from the defibrillator to avoid confusion in real emergencies.

### 3 SETUP

This section provides setup configuration instructions for the LIFEPAK CR-T AED Trainer. It also identifies default settings and describes the setting options, including the procedures for changing those setting options.

Setup Configuration and Operating Settings	page 16
Changing Options for Operating Settings	18

## SETUP CONFIGURATION AND OPERATING SETTINGS

The LIFEPAK CR-T AED Trainer setup configuration has eight operating settings that are used for training scenarios. These settings are initially preset to default settings based on clinical guidelines.

Table 7 lists the operating settings for the Trainer setup configuration, describes the options for each setting, and identifies the preset default for each setting. Your defibrillator may not have all of the functions identified in Table 7.

Table 7 Trainer Operating Setting Options

Operating Settings	Options/Description	Default Setting
SHOCK PROTOCOL	Six shock protocol options are available: four preset protocols and two user-defined protocols. The preset shock protocols cannot be modified during setup.	Custom #1
<ul style="list-style-type: none"> <li>• F1 - Fixed #1</li> <li>• F2 - Fixed #2</li> <li>• F3 - Fixed #3</li> <li>• F4 - Fixed #4</li> <li>• C1 - Custom #1</li> <li>• C2 - Custom #2</li> </ul>	<p>Three shocks, CPR time, one shock, one <i>NO SHOCK ADVISED</i>, CPR time.</p> <p>Four <i>NO SHOCK ADVISED</i> with CPR time. (See note.)</p> <p>Two shocks, one <i>NO SHOCK ADVISED</i>, CPR time, three <i>NO SHOCK ADVISED</i> with CPR time. (See note.)</p> <p>Two shocks, one <i>NO SHOCK ADVISED</i>, CPR time, two shocks, one <i>NO SHOCK ADVISED</i>, CPR time.</p> <p>Defined by instructor. (Refer to following note.)</p> <p>Defined by instructor. (Refer to following note.)</p> <p><b>Note:</b> For settings that include three or more consecutive <i>NO SHOCK ADVISED</i> prompts, Monitoring must be OFF. If Monitoring is ON, the Trainer enters a simulated monitoring state after the third consecutive <i>NO SHOCK ADVISED</i>.</p>	<p>Nine consecutive shocks with CPR time</p> <p>Same as C1 - Custom #1</p>
START PROMPT	When the Trainer lid is opened, two beeping tones confirm that the Trainer is turned ON and that a training scenario has begun. A <i>CALL FOR HELP</i> voice prompt can be added following the beeping tones.	Voice prompt on
PULSE PROMPTS	Three signs of life voice prompt options are available.	<i>CHECK FOR PULSE</i>
<ul style="list-style-type: none"> <li>• <i>CHECK FOR PULSE</i></li> <li>• <i>CHECK FOR BREATHING</i></li> <li>• <i>CHECK FOR SIGNS OF CIRCULATION</i></li> </ul>	<p>This prompt is for the more advanced trainee to check for a pulse.</p> <p>This prompt is for the lay trainee to check for signs of breathing.</p> <p>This prompt is for the lay trainee to check for signs of circulation.</p>	

Table 7 Trainer Operating Setting Options (Continued)

Operating Settings	Options/Description	Default Setting
MONITORING	Monitoring can be set to ON or OFF.	OFF
<ul style="list-style-type: none"> <li>ON</li> </ul>	After three consecutive <i>NO SHOCK ADVISED</i> , the Trainer enters a monitoring state. The instructor must press the CPSS button to simulate detection of a shockable rhythm.	
<ul style="list-style-type: none"> <li>OFF</li> </ul>	The monitoring state cannot be entered and the CPSS button is inactive.	
AUTOMATIC/ SEMIAUTOMATIC MODEL	The Trainer can be set up to simulate a defibrillator, automatic model (no SHOCK button) or semiautomatic model (SHOCK button).	Semiautomatic
<ul style="list-style-type: none"> <li>Automatic</li> </ul>	The Trainer automatically delivers a simulated shock. The shock button cover is stored in the storage compartment (refer to pages 3 and 4).	
<ul style="list-style-type: none"> <li>Semiautomatic</li> </ul>	The trainee must press the Trainer SHOCK button to deliver a simulated shock.	
CPR TIME	CPR Time is the time interval allowed between Trainer prompts to perform CPR. Seven CPR time intervals (in seconds) are available for CPR Time 1 and CPR Time 2: 15, 30, 45, 60, 90, 120, 180.	60 seconds
<ul style="list-style-type: none"> <li>CPR Time 1</li> </ul>	Occurs after three consecutive <i>SHOCK ADVISED</i> or when a <i>NO SHOCK ADVISED</i> follows a <i>SHOCK ADVISED</i> .	
<ul style="list-style-type: none"> <li>CPR Time 2</li> </ul>	Occurs after a <i>NO SHOCK ADVISED</i> .	
LANGUAGE OPTION	This option allows you to select the language spoken for voice prompts. Refer to Table 10 for available settings.	English

## CHANGING OPTIONS FOR OPERATING SETTINGS

The following paragraphs describe how to change the operating settings identified in Table 7. Included are paragraphs that discuss using the remote control and LED display when making changes and paragraphs that explain the procedural steps for completing the changes.

### Using the Remote Control and the LED Display

To make changes to the operating settings, you must use the remote control (shown previously in Figure 5, page 7) and the Trainer LED display.

Before you perform any of the procedures for changing operating settings, complete these steps:

- 1 If the Trainer is completely turned off, press the MASTER POWER switch forward and release it to provide power to the Trainer.
- 2 Stand behind the Trainer and hold the remote control level, unless the remote control cable is connecting the remote control and the Trainer.
- 3 As you complete the steps in the procedures that follow, view the LED display to ensure that the correct bars and colors illuminate.

**Note:** The LED bars illuminate until you save the setting and continue to the next action.

Figure 9 shows the LED display with its ten LED bars blank. Each bar corresponds to a setting function and illuminates when you initiate a change.

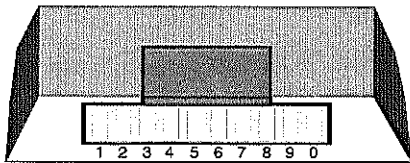

Figure 9 LED Display

### Procedures for Changing Operating Settings

The following paragraphs provide the procedural steps for changing operating settings. The procedures address Shock Protocol, General Operating Settings (including Start Prompt, Pulse Prompts, Monitoring, and Automatic/Semiautomatic Model), CPR Time, and the Language Option.

#### Shock Protocol













For most training scenarios, it is easiest to set up the shock protocol before the training session when the Trainer is in simulated OFF status (MASTER POWER switch ON, LID RELEASE/ON-OFF button OFF).



#### Selecting Shock Protocols

To select one of the fixed shock protocols, F1 through F4, or custom shock protocols, C1 or C2:

- 1 Press the GREEN SELECT button.
- 2 Refer to Table 8 to determine which protocol you want to enter and then press the appropriate button.
- 3 Press the GREEN SELECT button to save the selection. The signal sensor flashes, indicating the selection is saved, and the Trainer enters a simulated OFF status.

Table 8 Shock Protocol Options

Button	Shock Protocol	Order	LED Display*
F1 	Fixed #1	SSSSN	
F2 	Fixed #2	NNNN	
F3 	Fixed #3	SSNNNN	
F4 	Fixed #4	SSNSSN	
C1 	Custom #1	SSSSSSSSS	
C2 	Custom #2	SSSSSSSSS	

\*  = Shock (Green)     = No Shock (Red)     = End Scenario (Blank)

**Configuring Custom Shock Protocols**

You can change the Custom #1 and Custom #2 shock protocols to any configuration of *SHOCK* and *NO SHOCK ADVISED* prompts, up to nine selections.

To change Custom #1 and Custom #2 shock protocols:

- 1 Press the GREEN SELECT button.
- 2 Press either the MOTION button (C1) for Custom #1 or the PAUSE button (C2) for Custom #2.
- 3 Press the UP ▲ ARROW button to select shock or no shock. The first bar can be set only to shock or no shock.
- 4 Press the RIGHT ► ARROW button to advance to the next bar and press the UP ▲ ARROW button to select shock or no shock.
- 5 Repeat Step 4 until you have set the scenario you want to demonstrate and then press the UP ▲ ARROW button until remaining LED bars turn blank.
- 6 Press the GREEN SELECT button to save the change. The signal sensor flashes, indicating the change has been saved. The Trainer enters simulated OFF status.

Figure 10 shows the LED displaying the following shock protocol: Bar 1, no shock (red); Bar 2, shock (green); Bar 3, no shock (red); Bar 4, shock (green); Bar 5, end scenario (blank).

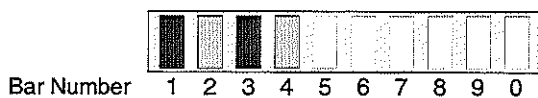

Figure 10 Custom #1 and #2 Options

### General Operating Settings

The procedure for changing the general operating settings (Start Prompt, Pulse Prompts, Monitoring, and Automatic/Semiautomatic Model) is the same for each. Table 9 identifies each general operating setting, indicates the LED bar that corresponds to the setting, and describes the options available.

**Table 9** General Operating Setting Options

Operating Setting	Bar Number	Options
Automatic/Semiautomatic Model	1	Green = Semiautomatic; Red = Automatic
Start Prompt	2	Green = Voice ON; Red = Voice OFF
Pulse Prompts	3	Red = <i>CHECK FOR PULSE</i> Yellow = <i>CHECK FOR SIGNS OF CIRCULATION</i> Green = <i>CHECK FOR BREATHING</i>
Monitoring	4	Green = ON; Red = OFF

To change the general operating settings:

- 1 Press the GREEN SELECT button.
- 2 Press the VOLUME button (OP, L).
- 3 Press the RIGHT ► ARROW button to advance to the desired operating setting (LED bar number).
- 4 Press the UP ▲ ARROW button to select the desired option (LED bar color).
- 5 Repeat steps 3 and 4 until you have changed all of the desired operating settings.
- 6 After making your changes, press the GREEN SELECT button to save the selections. The signal sensor flashes, indicating the selections have been saved. The Trainer enters simulated OFF status.

Figure 11 shows the LED displaying the following option settings:

- Bar 1, Automatic/Semiautomatic Model: Semiautomatic (green)
- Bar 2, Start Prompt: Voice ON (green)
- Bar 3, Pulse Prompts: *CHECK FOR BREATHING* (green)
- Bar 4, Monitoring: OFF (red)

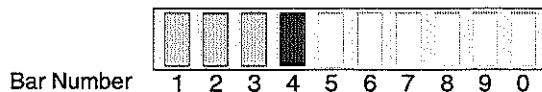

**Figure 11** General Operating Setting Options

## CPR Time

To change CPR Time 1 or CPR Time 2:

- 1 Press the RED SELECT button.
- 2 Press the NO SHOCK ADVISED button (T1) for CPR Time 1 and then proceed with steps 3 and 4.  
–or–  
Press the ATTENTION button (T2) for CPR Time 2 and then proceed with steps 3 and 4.
- 3 Press the RIGHT ► ARROW button to advance through the possible CPR time intervals. (Each bar illuminates red as you advance to it.)
- 4 When the bar corresponding to the desired time illuminates red, press the RED SELECT button to save the selection. The signal sensor flashes, indicating that the selection has been saved. The Trainer enters simulated OFF status.

Figure 12 shows the LED displaying the CPR Time set to 90 seconds.

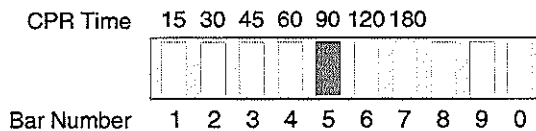

Figure 12 CPR Time Options

## Language Option

You can set the voice prompts to be delivered in any of up to six languages, depending on the language group ordered with your Trainer. There are four language groups available. Table 10 lists the language groups and the languages available in each group.

Table 10 Language Groups

Configuration	Bar 1	Bar 2	Bar 3	Bar 4	Bar 5	Bar 6
Group 1	English	Norwegian	Danish	Swedish	Finnish	
Group 2	English	Dutch	French	German	Spanish	Italian
Group 3	English	Hungarian	Polish	Iberian Portuguese	Brazilian Portuguese	Spanish
Group 4	English	Korean	Japanese	Mandarin		

To change the language option:

- 1 Press the RED SELECT button.
- 2 Press the VOLUME CONTROL (OP, L) button.
- 3 Press the RIGHT ► ARROW button until the desired bar illuminates red.
- 4 Press the RED SELECT button to save the selection. The signal sensor flashes, indicating that the selection has been saved. The Trainer enters simulated OFF status.

Figure 13 shows an example of a Trainer configured with Group 2 and the desired language is Spanish (Bar 5).

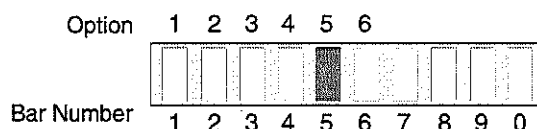

Figure 13 Language Options



## 4 CARING FOR THE LIFEPAK CR-T AED TRAINER

This section provides information about caring for the LIFEPAK CR-T AED Trainer.

Replacing Batteries	page 24
Troubleshooting	24
Cleaning	26
Product Recycling Information	26
Warranty	26
Accessories	27
Specifications	27

## REPLACING BATTERIES

When batteries for the LIFEPAK CR-T AED Trainer or the remote control become depleted or damaged, they should be replaced immediately. Refer to Section 1, page 8 for procedures detailing the steps for installing and replacing batteries in the Trainer and the remote control.

## TROUBLESHOOTING

Tables 11 through 15 provide checklists for troubleshooting LIFEPAK CR-T AED Trainer operating problems. If you cannot correct a problem, discontinue using the Trainer until the problem is resolved. Contact your local Medtronic Physio-Control representative.

**Note:** Do not disassemble the Trainer. There are no operator-serviceable components and operator disassembly may void the warranty.

Table 11 Voice Prompts and Tones Troubleshooting

Observation	Possible Cause	Corrective Action
Low volume; Trainer remains functional	<ul style="list-style-type: none"> <li>D-cell batteries are low</li> <li>Speaker grill partially covered</li> </ul>	<ul style="list-style-type: none"> <li>Replace D-cell batteries.</li> <li>Remove obstruction.</li> </ul>
Three beeping tones sound when the Trainer is turned OFF	<ul style="list-style-type: none"> <li>D-cell batteries are low</li> </ul>	<ul style="list-style-type: none"> <li>Replace D-cell batteries immediately.</li> </ul>
No sound; Trainer remains functional	<ul style="list-style-type: none"> <li>Speaker grill covered</li> <li>Speaker damaged</li> </ul>	<ul style="list-style-type: none"> <li>Remove blockage.</li> <li>Contact your local Medtronic Physio-Control representative.</li> </ul>
No sound; Trainer does not function	<ul style="list-style-type: none"> <li>D-cell batteries depleted or damaged</li> <li>Trainer damaged</li> </ul>	<ul style="list-style-type: none"> <li>Replace D-cell batteries.</li> <li>Contact your local Medtronic Physio-Control representative.</li> </ul>

Table 12 LED Display Troubleshooting

Observation	Possible Cause	Corrective Action
Intensity is fading (or inconsistent)	<ul style="list-style-type: none"> <li>Low battery</li> </ul>	<ul style="list-style-type: none"> <li>Replace D-cell batteries.</li> </ul>
Unlit when MASTER POWER switch pressed; Trainer does not function	<ul style="list-style-type: none"> <li>D-cell batteries depleted or damaged</li> <li>Trainer damaged</li> </ul>	<ul style="list-style-type: none"> <li>Replace D-cell batteries.</li> <li>Contact your local Medtronic Physio-Control representative.</li> </ul>
LED display scrolls yellow light back and forth	<ul style="list-style-type: none"> <li>Trainer detects interference</li> <li>Remote control operation not appropriate</li> </ul>	<ul style="list-style-type: none"> <li>Check for possible obstruction.</li> <li>Install remote control cable to improve connection.</li> </ul>

Table 13 Setup Options Troubleshooting

Observation	Possible Cause	Corrective Action
Voice prompts are out of sequence	<ul style="list-style-type: none"> <li>Incorrect operating setting options selected</li> </ul>	<ul style="list-style-type: none"> <li>Review setup procedures in Section 3, beginning on page 15.</li> </ul>
Voice prompts are incomplete	<ul style="list-style-type: none"> <li>Trainer damaged</li> </ul>	<ul style="list-style-type: none"> <li>Contact your local Medtronic Physio-Control representative.</li> </ul>
<i>CONNECT ELECTRODES</i> sequence repeats after training electrodes are connected to the Trainer	<ul style="list-style-type: none"> <li>Instructor did not press remote control to begin scenario sequence</li> <li>Damaged remote control</li> <li>Infrared sensor not working properly</li> </ul>	<ul style="list-style-type: none"> <li>Press the ELECTRODE PADS button once on the remote control to initiate voice prompts.</li> <li>Contact your local Medtronic Physio-Control representative.</li> <li>Clean or clear the signal sensor, if obstructed.</li> <li>Install remote control cable.</li> <li>Contact your local Medtronic Physio-Control representative.</li> </ul>

Table 14 Remote Control Troubleshooting

Observation	Possible Cause	Corrective Action
Trainer does not respond to remote control button presses	<ul style="list-style-type: none"> <li>Infrared sensor is not receiving remote control signal</li> <li>D-cell batteries depleted or damaged</li> <li>Remote control damaged</li> <li>Remote control batteries low</li> </ul>	<ul style="list-style-type: none"> <li>Reposition remote control relative to the Trainer.</li> <li>Remove anything blocking the signal sensor.</li> <li>Install remote control cable.</li> <li>Replace D-cell batteries.</li> <li>Replace remote control.</li> <li>Replace remote control batteries.</li> </ul>

Table 15 Training Electrodes Troubleshooting

Observation	Possible Cause	Corrective Action
Training electrode pads do not adhere to manikin	<ul style="list-style-type: none"> <li>Adhesive contaminated</li> </ul>	<ul style="list-style-type: none"> <li>Replace training electrode packet.</li> </ul>
Training electrode connector will not plug into the Trainer	<ul style="list-style-type: none"> <li>Training electrode connector damaged</li> <li>Trainer electrode receptacle damaged</li> </ul>	<ul style="list-style-type: none"> <li>Replace training electrode packet.</li> <li>Contact your local Medtronic Physio-Control representative.</li> </ul>

---

## **CLEANING**

Clean the Trainer, remote control, and the remote control cable by wiping surfaces with either:

- A lint-free, slightly damp cloth moistened with mild soap and water
- A lint-free, slightly damp cloth moistened with denatured alcohol

Observe the following precautions when cleaning:

- Do not immerse or soak the Trainer, remote control, or the cable.
- Do not use bleach, bleach dilution, or phenolic compounds.
- Do not steam or gas sterilize.

---

## **PRODUCT RECYCLING INFORMATION**

Recycle the Trainer and its accessories at the end of their useful life.

### **Recycling Assistance**

Items should be recycled according to national and local regulations. Contact your local Medtronic Physio-Control representative for assistance.

### **Preparation**

Items should be clean and contaminant-free prior to being recycled.

### **Recycling of Training Electrodes**

After training electrodes have reached the end of their useful life, follow your local clinical procedures for recycling.

### **Packaging**

Packaging should be recycled according to national and local regulations.

---

## **WARRANTY**

In the USA, call 1.800.442.1142. Outside the USA, contact your local Medtronic Physio-Control representative for warranty information.

## ACCESSORIES

The following accessories are available for the LIFEPAK CR-T AED Trainer:

Table 16 LIFEPAK CR-T AED Trainer Accessories

Accessory	Part Number
QUIK-PAK Training Electrode Packet	3201805
Shock Button Cover	3201801
Remote Control and Cable	3201799
Serial Cable	3201802
CHARGE-PAK Trainer	3201800
Quick Reference Card	3201508
Soft Case	3201803
Soft Case Cards	3201792
International Lid Labels	3201755

## SPECIFICATIONS

Table 17 lists the specifications for the LIFEPAK CR-T AED Trainer. Table 18 lists the specifications for the remote control.

Table 17 LIFEPAK CR-T AED Trainer Specifications

General	Device designed for low impact, low stress environments. For use in temperature-controlled areas protected from precipitation. Capable of withstanding heavy usage and prolonged periods of operation.
Physical Characteristics	Height: 10.7 cm (4.2 in.) Width: 20.3 cm (8.0 in.) Depth: 24.1 cm (9.5 in.), excluding handle Weight: 2.1 kg (4.6 lb) with batteries
Batteries	6 volts/4 cells, range 3.4 Vdc ~ 6.5 Vdc Four non-rechargeable D-cell alkaline batteries. New batteries will provide not less than 100 hours of continuous operation under normal indoor-environment conditions.
Buttons	Master ON/OFF, lid release/ON-OFF, shock
Speaker	Volume output: Hi, Med., Low
Operating Temperature	3° to 38° C (37° to 100° F)
Storage Temperature	-10° to 60° C (14° to 140° F) (remove batteries for storage)
Water Resistance	Spillage resistance per IEC 601-1, part 44.3

**Table 18** Remote Control Specifications

Transmission	Wireless infrared signal. Range, 3 meters max 82-inch (2-meter) optional cable attachment
Size	4.57 cm x 3.38 cm x 1.65 cm (1.8 in. x 1.3 in. x .6 in.)
Weight (without batteries)	32 grams (.08 lb)
Batteries	3 volts supplied from two AAA alkaline batteries
Buttons	13-key membrane switch pad labeled for the following functions: NO SHOCK, SERVICE REQUIRED, ELECTRODE PAD CONTACT, MOTION, REPLACE CHARGE-PAK, CPSS, PAUSE, VOLUME CONTROL, LOW INTERNAL BATTERY, SETUP NAVIGATION BUTTONS
Operating Temperature	3° to 38° C (37° to 100° F)
Storage Temperature	-10° to 60° C (14° to 140° F) (remove batteries for storage)
Water Resistance	Spillage resistance per IEC 601-1, part 44.3

---

**APPENDIX A  
LIFEPAK CR-T AED TRAINER  
VOICE PROMPTS AND TONES**



Voice Prompts and Tones Table

Voice Prompt	Tones
<i>CALL FOR HELP NOW</i>	After the AED Trainer lid opens, two beeping tones sound. If the start option is set to voice prompts, this voice prompt will sound following the beeping tones.
<i>REMOVE CLOTHING FROM CHEST</i>	
<i>PULL RED HANDLE TO OPEN BAG</i>	
<i>PEEL EACH PAD OFF BLUE PLASTIC</i>	
<i>AND APPLY PADS TO EXPOSED CHEST</i>	
<i>DO NOT TOUCH PATIENT EVALUATING HEART RHYTHM</i>	Two beeping tones sound to simulate heart rhythm analysis.
<i>MOTION DETECTED</i>	
<i>STOP MOTION</i>	
<i>STAND BY PREPARING TO SHOCK</i>	
<i>EVERYONE CLEAR</i>	
<i>PRESS FLASHING BUTTON</i>	Semiautomatic model only. An alarm tone sounds until the shock button is pressed.
<i>DO NOT TOUCH PATIENT DELIVERING SHOCK</i>	An alarm tone sounds until the shock button is pressed (semiautomatic model) or until a simulated shock is delivered (automatic model).
<i>SHOCK DELIVERED</i>	
<i>SHOCK NOT DELIVERED</i>	
<i>NO SHOCK ADVISED</i>	
<i>CHECK FOR PULSE IF NO PULSE START CPR</i>	
<i>CHECK FOR BREATHING IF NOT BREATHING START CPR</i>	
<i>CHECK FOR SIGNS OF CIRCULATION IF NO SIGNS OF CIRCULATION START CPR</i>	
<i>CONTINUE CARE</i>	
<i>CHECK PADS FOR GOOD CONTACT</i>	





**APPENDIX B  
LIFEPAK CR-T AED TRAINER  
QUICK START REFERENCE CARD**









**LIFEPAK® CR-T AED TRAINER**  
Quick Start Reference Card



**Quick Start Setup Procedure**

- 1 Turn on the Trainer using the MASTER POWER switch.
- 2 Press the GREEN SELECT  button on the remote control.
- 3 Select the desired shock protocol (the default setting is C1) using the buttons referenced in the following table.
- 4 Press the GREEN SELECT  button again to confirm shock protocol. The Trainer enters simulated OFF status.
- 5 You are now ready to begin a training session.
- 6 When the electrode pads are properly placed on the manikin, press the ELECTRODE PADS  button on the remote control.
- 7 Use the remote control to create troubleshooting situations. Refer to the opposite side of this card for details.

Remote Control Button	AED Trainer Shock Protocol	Shock Order*
F1 	Fixed #1	SSSSN
F2 	Fixed #2	NNNN
F3 	Fixed #3	SSNNNN
F4 	Fixed #4	SSNSSN
C1** 	Custom #1	SSSSSSSS
C2** 	Custom #2	SSSSSSSS



\* S: Shock Advised (green LED)  
N: No Shock Advised (red LED)







\*\* Custom settings, C1 and C2, may be changed (refer to operating instructions).

**LIFEPAK® CR-T AED TRAINER**  
Quick Start Reference Card



**Quick Start Setup Procedure**

- 1 Turn on the Trainer using the MASTER POWER switch.
- 2 Press the GREEN SELECT  button on the remote control.
- 3 Select the desired shock protocol (the default setting is C1) using the buttons referenced in the following table.
- 4 Press the GREEN SELECT  button again to confirm shock protocol. The Trainer enters simulated OFF status.
- 5 You are now ready to begin a training session.
- 6 When the electrode pads are properly placed on the manikin, press the ELECTRODE PADS  button on the remote control.
- 7 Use the remote control to create troubleshooting situations. Refer to the opposite side of this card for details.

Remote Control Button	AED Trainer Shock Protocol	Shock Order*
F1 	Fixed #1	SSSSN
F2 	Fixed #2	NNNN
F3 	Fixed #3	SSNNNN
F4 	Fixed #4	SSNSSN
C1** 	Custom #1	SSSSSSSS
C2** 	Custom #2	SSSSSSSS

\* S: Shock Advised (green LED)  
N: No Shock Advised (red LED)

\*\* Custom settings, C1 and C2, may be changed (refer to operating instructions).

**LIFEPAK® CR-T AED TRAINER**  
Quick Start Reference Card



Button	Function	Button	Function
	Press to change <i>SHOCK ADVISED</i> to <i>NO SHOCK ADVISED</i> . Function is active only during simulated analysis.		Press once to activate the <i>ATTENTION</i> indicator in the readiness display. To clear, press the button again.
	Press to advance the training electrodes to ON or OFF.		Press any time to suspend device operation. Press again to resume operation at point of interruption.
	Press to advance <i>MOTION DETECTED</i> to ON or OFF. This feature is active during simulated analysis only.		Press to change the speaker volume. The volume level scrolls up, and returns to lowest level after the highest is reached.
	Press to activate <i>WRENCH</i> indicator on the readiness display (active only when Trainer is in simulated OFF status). To clear, press the button again.		Press to enter the <i>GREEN SELECT</i> button operating settings.
	Press to activate <i>CHARGE-PAK</i> indicator on the readiness display (active only when Trainer is in simulated OFF status). To clear, press the button again.		Press to enter the <i>RED SELECT</i> button operating settings.
	Press to simulate detection of a shockable rhythm during Monitoring (CPSS) state.		Press the <i>RIGHT ARROW</i> button to advance to the next operating setting.
			Press the <i>UP ARROW</i> button to select the desired option.

**LIFEPAK® CR-T AED TRAINER**  
Quick Start Reference Card



Button	Function	Button	Function
	Press to change <i>SHOCK ADVISED</i> to <i>NO SHOCK ADVISED</i> . Function is active only during simulated analysis.		Press once to activate the <i>ATTENTION</i> indicator in the readiness display. To clear, press the button again.
	Press to advance the training electrodes to ON or OFF.		Press any time to suspend device operation. Press again to resume operation at point of interruption.
	Press to advance <i>MOTION DETECTED</i> to ON or OFF. This feature is active during simulated analysis only.		Press to change the speaker volume. The volume level scrolls up, and returns to lowest level after the highest is reached.
	Press to activate <i>WRENCH</i> indicator on the readiness display (active only when Trainer is in simulated OFF status). To clear, press the button again.		Press to enter the <i>GREEN SELECT</i> button operating settings.
	Press to activate <i>CHARGE-PAK</i> indicator on the readiness display (active only when Trainer is in simulated OFF status). To clear, press the button again.		Press to enter the <i>RED SELECT</i> button operating settings.
	Press to simulate detection of a shockable rhythm during Monitoring (CPSS) state.		Press the <i>RIGHT ARROW</i> button to advance to the next operating setting.
			Press the <i>UP ARROW</i> button to select the desired option.